

INSTRUCTION MANUAL

RA 59 RACK ADAPTER

KEPCO INC.
An ISO 9001 Company.

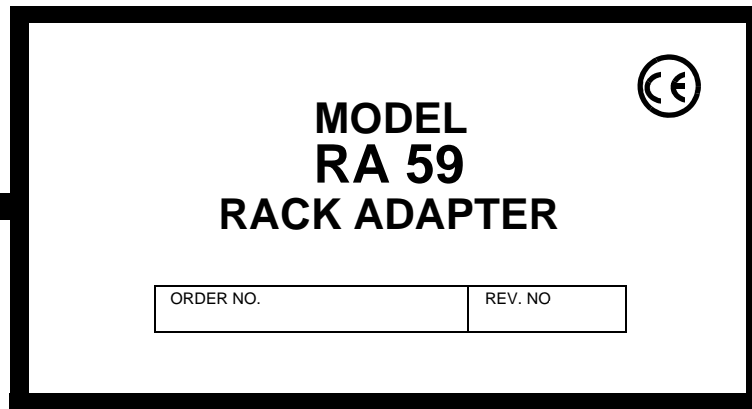

IMPORTANT NOTES:

- 1) This manual is valid for the following Model and associated serial numbers:

MODEL	SERIAL NO.	REV. NO.
-------	------------	----------

- 2) A Change Page may be included at the end of the manual. All applicable changes and revision number changes are documented with reference to the equipment serial numbers. Before using this Instruction Manual, check your equipment serial number to identify your model. If in doubt, contact your nearest Kepco Representative, or the Kepco Documentation Office in New York, (718) 461-7000, requesting the correct revision for your particular model and serial number.
- 3) The contents of this manual are protected by copyright. Reproduction of any part can be made only with the specific written permission of Kepco, Inc.

Data subject to change without notice.

©2013, KEPCO, INC
P/N 243-0910c



KEPCO, INC. ● 131-38 SANFORD AVENUE ● FLUSHING, NY. 11355 U.S.A. ● TEL (718) 461-7000 ● FAX (718) 767-1102
email: hq@kepcopower.com ● World Wide Web: <http://www.kepcopower.com>

TABLE OF CONTENTS

SECTION	PAGE
SECTION 1 - INTRODUCTION	
1.1	Scope of Manual 1-1
1.2	General Description..... 1-1
1.3	Accessories 1-2
SECTION 2 - INSTALLATION	
2.1	Unpacking and Inspection 2-1
2.2	Rack Adapter Keying Instructions 2-1
2.2.1	Establishing Key Positions..... 2-1
2.3	Terminations..... 2-2
2.4	Source Power Requirements 2-2
2.5	Cooling 2-2
2.6	Installation 2-3
2.7	Wiring Instructions..... 2-3
2.7.1	Safety Grounding..... 2-3
2.7.2	Source Power Connections 2-3
2.7.3	Source Power Configurations..... 2-4
2.7.3.1	A-C Source Power, Single Phase 2-4
2.7.3.2	D-C Source Power 2-5
2.7.4	Control Signal Connections 2-5
2.7.5	Output Load Connections..... 2-5
2.7.5.1	Parallel/Redundant Operation..... 2-5
2.7.5.2	Series/Independent Operation 2-5
2.7.5.3	Mixed Operation..... 2-5
2.8	Bus Bar Link Removal/Installation..... 2-6
2.9	Shipping 2-6

LIST OF FIGURES

FIGURE	TITLE	PAGE
1-1	RA 59 Rack Adapter	iv
1-2	Mechanical Outline Drawing, RA 59 Rack Adapter.....	1-3
2-1	Key Pin Location	2-1
2-2	Rear Panel Connections	2-2
2-3	Single Phase A-C.D-C Source Power Wiring.....	2-4
2-4	Bus Bar Link Removal/Installation	2-7

LIST OF TABLES

TABLE	TITLE	PAGE
1-1	Accessories	1-2
2-1	Equipment Supplied	2-1

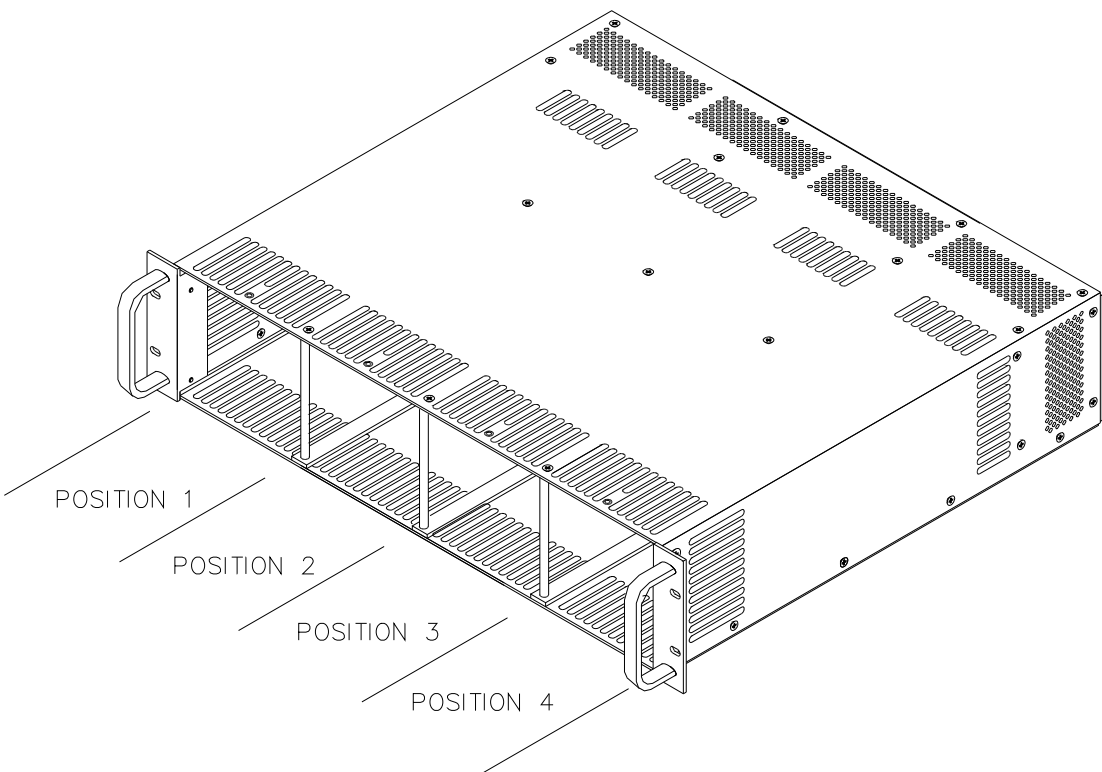

3040834

FIGURE 1-1. RA 59 RACK ADAPTER

SECTION 1 - INTRODUCTION

1.1 SCOPE OF MANUAL

This manual contains instructions for the installation and operation of the RA 59 plug-in rack adapter (Figure 1-1) used with HSP Series power supplies, manufactured by Kepco, Inc., Flushing, New York, U.S.A.

1.2 GENERAL DESCRIPTION

The Kepco RA 59 rack adapter is specifically designed for the installation of Kepco HSP Series Power Supplies into 24-inch EIA standard equipment racks. Each rack adapter accommodates from one to four HSP power supplies. An internal plate assembly mounts connectors which interface directly with the power and signal connectors of HSP series power supplies, permitting pluggable insertion and extraction, while a separate external rear panel contains the fixed power and signal connections. Separate source power, signal, and load terminations are provided for each of the four power supply mounting positions. Internal power output configurations differ for the three models as follows:

Output power connections for all four positions may be connected internally via removable shorting bus bars. These allow the user to customize each position of the rack adapter for series, parallel, or independent operation. The unit is shipped with all four positions configured for independent operation (factory default).

External dimensions and all mechanical and electrical specifications are contained in the outline drawing: Figure 1-2.

Each rack adapter occupies 5.22 inches (132.5 mm) of vertical space and has a maximum depth protrusion of 20.75 inches as measured from the mounting surface of the "ear" brackets. The rack adapter is shipped with mounting ears for flush mounting in EIA 24-inch equipment racks. The rack adapter can be fitted with optional blank tiller panels in both 1/4 and 1/2 rack dimensions if the full complement of four power supplies is not utilized.

1.3 ACCESSORIES

Accessories are listed in Table 1-1. See Table 2-1 for Equipment Supplied.

TABLE 1-1. ACCESSORIES

ACCESSORY	PART NUMBER	USE
CONNECTORS	142-0422	I/O connector mating plug.
	108-0294	I/O connector backshell (includes retention screws).
FILLER PANELS	RFP 60-1	Covers 1/4 of front panel.
	RFP 60-2	Covers 1/2 of front panel.
ALUMINUM FEET	158-0004	Aluminum feet attach to bottom of rack adapter (set of four).
SCREW	101-0215	Used to attach aluminum feet to rack adapter.
BUS BAR LINK KIT	219-0429	Used to connect + and – terminals of adjacent power supplies for parallel configurations (two links per kit). See PAR. 2.8 and Figure 2-4 for details.
SCREW	101-0456	Pan head, phillips, self-forming, 6-32 x 1/4 used to attach bus bar links.
SAFETY COVER, DC **	137-0135	Covers DC output power connections for one slot.
SUPPORT BRACKET (REAR)	128-1909	Auxiliary support when rack adapter fully populated with 4 power supplies. Two (2) brackets required for each rack adapter. Mount each bracket using two (2) 6-32 X 3/8" thread-forming screws (Kepco p/n 101-0456) and two (2) internal tooth lock washers (Kepco p/n 103-0015), see Figure 1-2.
SCREW, THREAD FORMING 6-32 X 3/8"	101-0456	Two (2) screws required to mount each rear support bracket.
LOCKWASHER, INTERNAL TOOTH	103-0015	Two (2) lockwashers required to mount each rear support bracket.
** If AC Input safety cover required, contact Kepco.		

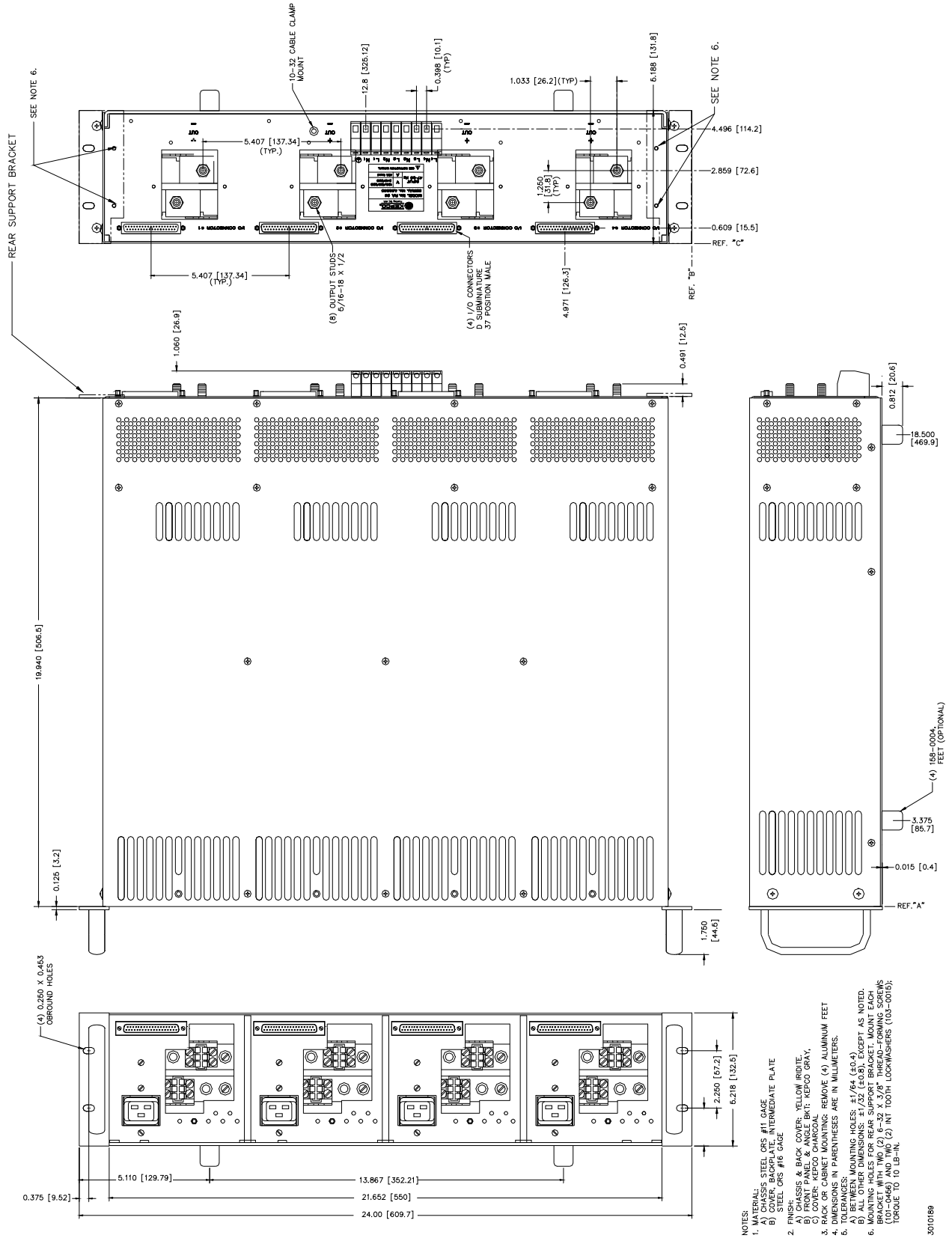

FIGURE 1-2. MECHANICAL OUTLINE DRAWING, RA 59 RACK ADAPTER

SECTION 2 - INSTALLATION

2.1 UNPACKING AND INSPECTION

This equipment has been thoroughly inspected and tested prior to packing and is ready for operation. After careful unpacking, inspect for shipping damage before attempting to operate. If any indication of damage is found, file an immediate claim with the responsible transport service. See Table 2-1 for a list of equipment supplied.

TABLE 2-1. EQUIPMENT SUPPLIED

ITEM	QUANTITY	PART NUMBER
Rack Adapter	1	RA 59
I/O Connector (Mating)	4	142-0422
Instruction Manual	1	243-0910
Split Lockwasher *	8	103-0005
Hex Nut 5/16-18 *	8	102-0105
* Mounting hardware is assembled to output studs.		

2.2 RACK ADAPTER KEYING INSTRUCTIONS

The RA 59 rack adapter incorporates a keying mechanism to prevent accidental insertion of the incorrect model HSP power supply into any position. The HSP power supplies are keyed by voltage at the factory. The keying mechanism will prevent engagement of any of the HSP power supply's connectors with those on the rack adapter's intermediate plate unless the key and keyway align. The user can configure each power supply position of the rack adapter for the desired voltage in the desired position; the factory default keying is for the 5 volt HSP module (see Figure 2-1).

2.2.1 ESTABLISHING KEY POSITIONS

The key pins (Kepco PIN 108-0079) used for module keying are located on the intermediate plate (see Figure 2-1) and are accessed through the front of the rack adapter. To alter the keying of any position, simply unscrew the key pin from the intermediate plate using a 1/4" nut driver or deep socket, reposition key pin at new location and retighten. HSP module keying is identified in Figure 2-1 and in the HSP operator's manual. **DO NOT ALTER THE KEYING AT THE POWER SUPPLY!**

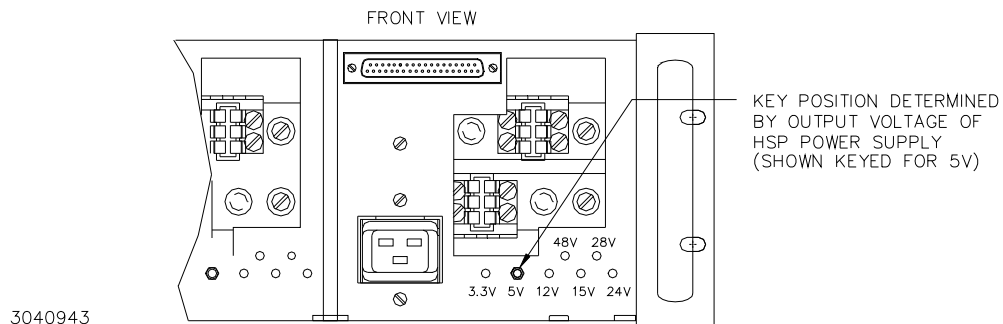

FIGURE 2-1. KEY PIN LOCATION

2.3 TERMINATIONS

All input, output and control terminations are located on the rear panel of the rack adapter (see Figure 2-2). Other than module keying (Para.2.2), no adjustments or alignments are required.

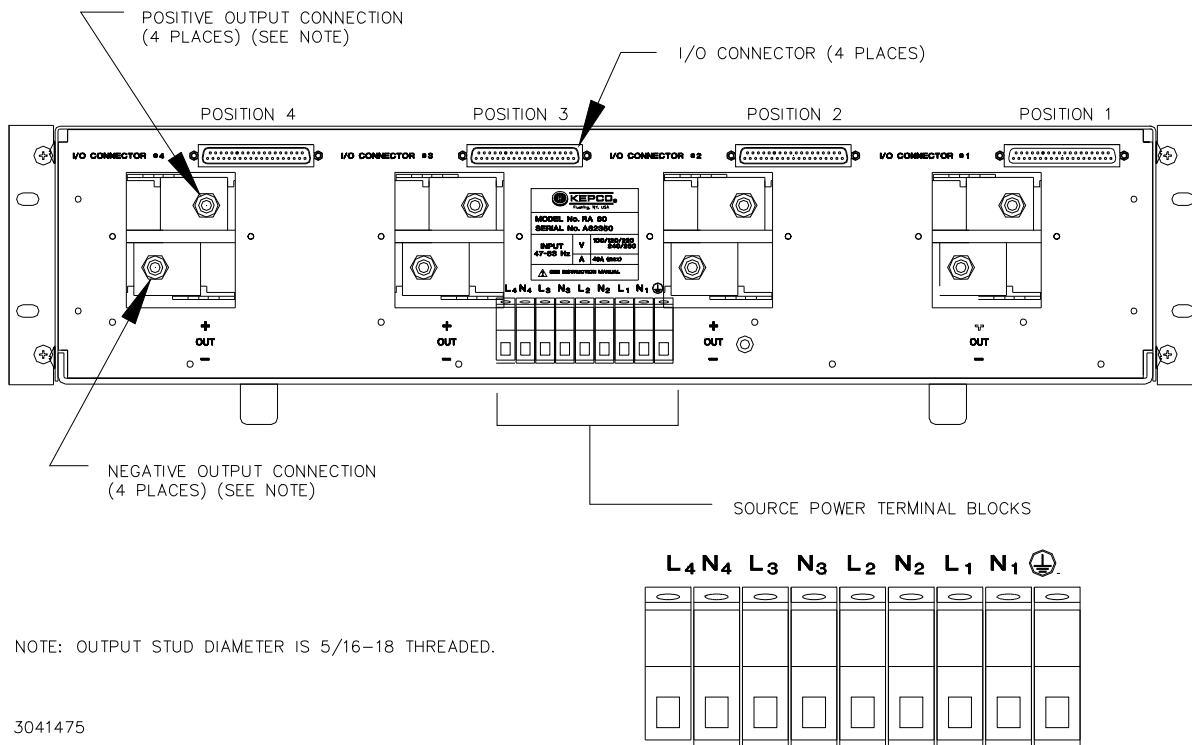

FIGURE 2-2. REAR PANEL CONNECTIONS

2.4 SOURCE POWER REQUIREMENTS

When used in conjunction with Kepco HSP series power supplies, this rack adapter can be operated from single-phase a-c source power without adjustment or modification. Voltage and frequency limits are determined by the source power rating of the HSP power supplies. Operation from d-c or three-phase a-c power is also available: please contact factory.

2.5 COOLING

The HSP power supplies mounted within the rack adapter are maintained within their operating temperature range by means of internal cooling fans. ALL INLET AND EXHAUST OPENINGS AROUND THE RACK ADAPTER CASE MUST BE KEPT CLEAR OF OBSTRUCTION TO ENSURE PROPER AIR ENTRY AND EXHAUST. Care must be taken that the ambient temperature, which is the temperature of the air immediately surrounding the rack adapter, does not rise above the specified limits for the operating load conditions of the installed HSP power supplies. Kepco recommends providing additional space above and below the rack adapter where possible when the rack adapter is fully populated.

2.6 INSTALLATION (Refer to “Mechanical Outline Drawing,” Figure 1-2.)

The RA 59 rack adapter is designed for rack-mounted applications, The rack adapter will mount directly to EIA standard 24” racks. Other fixed mounting applications are possible; consult factory for details.

When used in fixed rack-mounted applications, the rack adapter is attached to the rack via the two mounting ears. Two screws are required per mounting ear for proper support. Kepeco recommends using auxiliary support when the rack adapter is fully populated with four HSP power supplies to accommodate the weight of the power supplies and associated load cables: either a shelf, rear support brackets or side support brackets (see Table 1-1).

For all installations provide adequate clearance around air inlet and exhaust locations and ensure that the temperature immediately surrounding the unit, and especially near the air inlets, does not exceed the maximum specified ambient temperature for the operating conditions of the installed power supplies.

CAUTION

WHEREVER POSSIBLE RACK ADAPTER SHOULD BE MOUNTED BEFORE INSTALLING POWER SUPPLIES TO AVOID DISTORTION OF THE RACK ADAPTER (INSTALL POPULATED RACK ADAPTER ONLY IF BOTTOM OF RACK ADAPTER IS FULLY SUPPORTED). FAILURE TO OBSERVE THIS CAUTION MAY RESULT IN MISALIGNMENT OF THE POWER SUPPLIES WITH THE RACK ADAPTER.

2.7 WIRING INSTRUCTIONS

Interconnections between an a-c power source and a stabilized power supply, and between the power supply and its load are as critical as the interface between other types of electronic equipment. If optimum performance is expected, certain rules for the interconnection of source, power supply and load must be observed by the user. These rules are described in detail in the following paragraphs and in the operating instructions for HSP Series power supplies.

2.7.1 SAFETY GROUNDING

Local, national and international safety rules dictate the grounding of the metal cover and case of any instrument connected to the a-c power source, when such grounding is an intrinsic part of the safety aspect of the instrument. The instructions below suggest wiring methods which comply with these safety requirements; however, in the event that the specific installation for the power system involves differences with the recommended wiring, it is the customer's responsibility to ensure that all applicable electric codes for safety grounding requirements are met.

2.7.2 SOURCE POWER CONNECTIONS

The rear panel of the RA 59 rack adapter (Figure 2-2) includes nine terminal blocks to allow for individual connection of single-phase a-c and d-c input power to each position, These terminal blocks are labeled LI, NI, L2, N2, L3, N3, L4, N4, and G. Each terminal block will accommodate up to #6 AWG (16mm²) or equivalent conductor size. Their functions are as follows:

- **Terminal G (Ground)** is the safety ground connection for the rack adapter, and is connected to the rack adapter chassis as well as to the safety ground terminal of the source power connector of each of the three power supply mounting positions. Regardless of the type Of source power provided, Terminal G must be connected to safety ground in

order to ensure proper grounding of the HSP power supplies when installed. The conductor used to connect Terminal G to safety ground must be sized to support the total fault current of all of the power supplies installed in the rack adapter: for HSP series power supplies, the ground fault current rating is 20 amperes per power supply. Consult local electric codes for the proper wire size to carry the required fault current.

- **Terminal pairs L1/N1, L2/N2, L3/N3, L4/N4** are connected to the high-side and low-side contacts of the source power connectors for each of the three power supply mounting positions (1, 2, 3 and 4) of the rack adapter (see Figure 2-2). Each terminal pair (Lx/Nx) is isolated from the remaining two pairs, facilitating redundant source power connections if desired. The conductor used to connect terminals Lx and Nx to source power must be sized for the 16 ampere maximum source current drawn by HSP Series power supplies; Kepco recommends #14 AWG (2.5mm²) or equivalent minimum conductor size to support this current.

2.7.3 SOURCE POWER CONFIGURATIONS

The following standard wiring configurations are recommended by Kepco as being compliant with national and international safety standards. It is the user's responsibility to ensure that all applicable local electric codes are met. The minimum and maximum limits for source power voltage are defined in HSP series power supply specifications.

CAUTION

UNDER NO CIRCUMSTANCES SHOULD THE STEADY-STATE SOURCE VOLTAGE APPLIED ACROSS ANY Lx/Nx PAIR EXCEED 277V rms!

2.7.3.1 A-C SOURCE POWER, SINGLE PHASE

For single-phase a-c source power, connect Terminal G of the rack adapter to source power safety ground; then connect a separate wire pair from the power source to each Lx/Nx terminal block pair to be populated by an HSP power supply (see Figure 2.3).

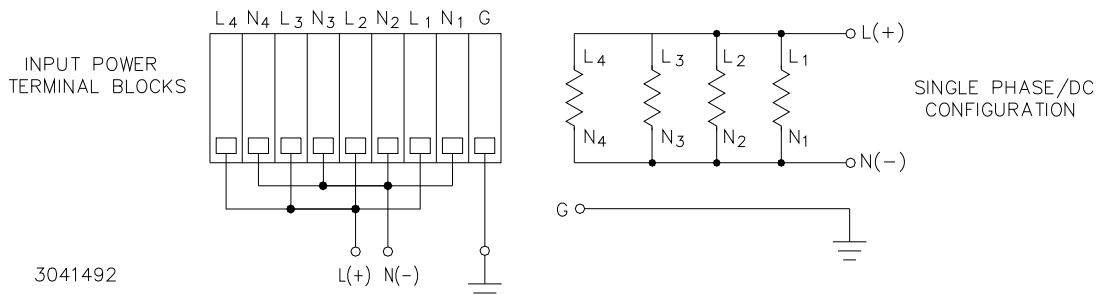

FIGURE 2-3. SINGLE PHASE A-C-D-C SOURCE POWER WIRING

If desired, a single wire pair can be run from the power source to any Lx/Nx pair, with jumpers connecting the remaining Lx/Nx pairs to the first pair; however, the wires must be adequately rated to support the total current being delivered through them. For the example shown in Figure 2-3, the jumper wires are sized for 16 amps, but the source wires must be sized for 4 times 16 amps, or 64 amps.

2.7.3.2 D-C SOURCE POWER

For d-c source power, wire the rack adapter in accordance with the instructions for single-phase a-c power per Para. 2.7.3.1. Contact Kepco Applications Engineering for additional restrictions imposed by d-c source power.

2.7.4 CONTROL SIGNAL CONNECTIONS

Access to the control signal (I/O) connector for each HSP power supply is provided via the four 37-pin D-subminiature connectors on the rear panel of the rack adapter (see Figure 2-2). Four mating connectors (Kepco PN 142-0422) are provided in a plastic bag. These connectors are simply extensions of the identical connectors located on the HSP power supplies. Consult the HSP operator's manual for instructions on wiring and use of these control lines.

2.7.5 OUTPUT LOAD CONNECTIONS

Load connections to the rack adapter is achieved via the stud pairs located on the rear panel directly behind each mounting position (see Figure 2-2). Required hardware for attaching output cables are assembled to the output studs. The RA 59 rack adapter employs a modular bus bar system to permit a variety of load configurations; it is shipped with all four positions configured for independent operation. The following sections describe additional output bus bar configurations available with the RA 59 rack adapter. Additional information regarding these and other load interface requirements are contained in the HSP operators manual.

NOTE!

REGARDLESS OF OUTPUT CONFIGURATION, OUTPUT SENSE
LINES MUST BE PROPERLY CONNECTED FOR OPERATION
(REFER TO HSP OPERATOR'S MANUAL).

2.7.5.1 PARALLEL/REDUNDANT OPERATION

Adjacent positions of the RA 59 rack adapter can be reconfigured for parallel/redundant operation by installing optional bus bar links as shown in Figure 2.4. Load wiring is attached to the rack adapter at the output studs. Although load wiring can be attached to any single position, Kepco strongly recommends distributing the load interface evenly among the populated power supply positions to minimize load sharing error; in no case should load current drawn from any one terminal exceed 300 Amperes. All four load connections must be used when the 3.3 volt and 5 volt modules are used. Consult HSP operators manual for additional information regarding parallel/ redundant load operation.

2.7.5.2 SERIES/INDEPENDENT OPERATION

The RA 59 rack adapter can be configured for series operation of HSP power supplies by installing a jumper cable from the negative bus bar of one independent position to the positive bus bar of the adjacent independent position for as many positions as required. Consult the HSP operators manual for additional information regarding series operation; contact Kepco Applications Engineering for additional information.

2.7.5.3 MIXED OPERATION

The design of the RA 59 permits the user to configure HSP power supplies for almost any combination of independent, series and parallel operation, both within a single rack adapter and between different RA 59 rack adapters, within the limits of the HSP operation envelope. The

user must ensure that the requirements for each configuration stated above are met. If any questions or problems arise, the user is encouraged to contact Kepco Applications Engineering group for technical assistance.

2.8 BUS BAR LINK REMOVAL/INSTALLATION REFER TO FIGURE 2-4



BE SURE ALL POWER IS DISCONNECTED FROM RACK ADAPTER BEFORE DISASSEMBLY.

Two bus bar links and the associated attaching hardware included in Kit 219-0429 (see Figure 2-4) are used to connect the (+) and (-) terminals of an adjacent pair of power supplies.

NOTE: To connect all four power supplies of the RA 59 rack adapter for parallel/redundant operation, three Bus Bar Link Kits, P/N 219-0429, are required.

- a. Remove eight screws (2) and eight lockwashers (1) securing the four I/O connector assemblies (10) to the chassis (9).
- b. Remove 12 screws (8) from the top, bottom, and sides of chassis (9). Carefully separate backplate assembly (3) from chassis (9) and swing down (with wires attached) to expose bus bar links (4).
- c. To install a bus bar link (4), use four screws (7), lockwashers (6), and flat washers (5) to attach bus bar link (4) to backplate assembly (3).
- d. To remove a bus bar link (4), remove four screws (7), lockwashers (6), and flat washers (5) securing bus bar link (4) to backplate assembly (3).
- e. Assemble backplate assembly (3) to chassis (9) (taking care that wires are not crimped) using eight screws (2) and lockwashers (1).
- f. Secure backplate assembly (3) to chassis (9) using 12 screws (8)

2.9 SHIPPING

Shipping of the rack adapter is recommended only after the HSP power supplies have been removed from the rack adapter. Contact Kepco Applications Engineering if further assistance is required.

KEY TO Figure 2-4:

1. Lockwasher, Internal tooth, #4 - P/N 103-0014 (2 per I/O connector)
2. Screw (2 per I/O connector - part of Jackpost Kit P/N 108-0203)
3. Backplate Assembly
4. ** Bus Bar Link - P/N 172-0513 (2)
5. ** Flat washer, #6 - P/N 103-0100 (4 per bus bar link)
6. ** Lockwasher, Split, #6 - P/N 103-0066 (4 per bus bar link)
7. ** Screw, 6-32 x 1/4" PPH, self-forming, P/N101-0456 (4 per bus bar link)
8. Screw, 6-32 x 5/16" FHPO - P/N 101-0408 (12)
9. Chassis
10. I/O Connector Assembly

** Items included in KIT 219-0429

NOTE: Quantities are indicated in parentheses.

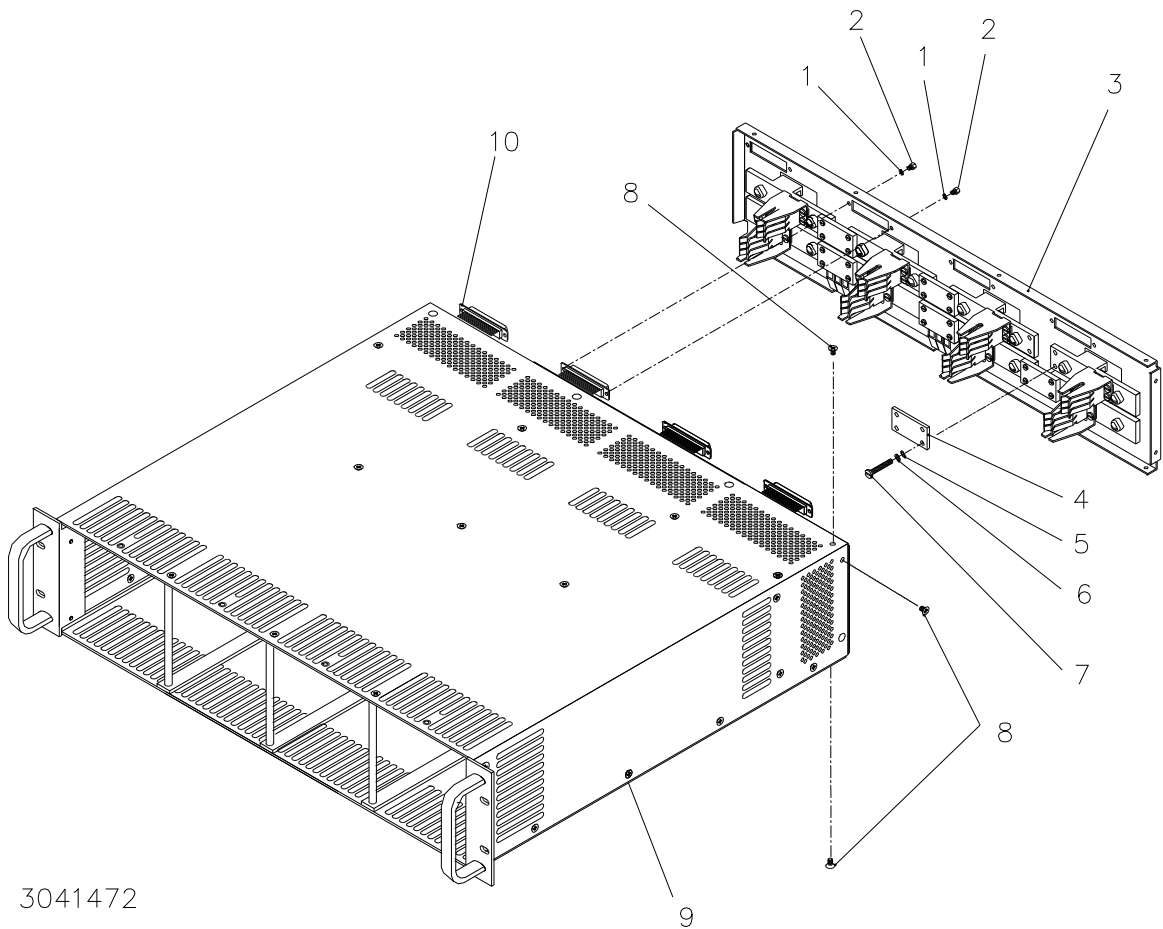

3041472

FIGURE 2-4. BUS BAR LINK REMOVAL/INSTALLATION

